

Custom Fabrication & Specialty Items

Hose Barbs



Aluminum Circle Lock Hose Barbs

Female		
Size	Part Number	Price
4"	IH240004	
6"	IH240006	
8"	IH240008	
10"	IH240010	
12"	IH240012	

Male		
Size	Part Number	Price
4"	IH240404	
6"	IH240406	
8"	IH240408	
10"	IH240410	
12"	IH240412	

Aluminum Midwest Hose Barbs

Female		
Size	Part Number	Price
6"	IH140006	
8"	IH140008	
10"	IH140010	
12"	IH140012	

Male		
Size	Part Number	Price
6"	IH140406	
8"	IH140408	
10"	IH140410	
12"	IH140412	

Galvanized Steel Circle Lock Hose Barbs

Female		
Size	Part Number	Price
4"	SH140004	
6"	SH140006	
8"	SH140008	
10"	SH140010	
12"	SH140012	

Male		
Size	Part Number	Price
4"	SH140404	
6"	SH140406	
8"	SH140408	
10"	SH140410	
12"	SH140412	

Plain End Hose Barbs

Aluminum		
Size	Part Number	Price
3"	IH140203	
4"	IH140204	
5"	IH140205	
6"	IH140206	
8"	IH140208	
10"	IH140210	
12"	IH140212	

Steel		
Size	Part Number	Price
4"	SH140204	
6"	SH140206	
8"	SH140208	
10"	SH140210	
12"	SH140212	

KROY INDUSTRIES, INC.

Prices Effective: January 1, 2020.. Prices Subject to Change Without Notice
 Phone: 402-362-6651 or 888-477-5769 * Fax: 402-362-6566 * York, Nebraska

Custom Fabrication & Specialty Items

Aluminum

Cast 45 Degree Welding Elbow

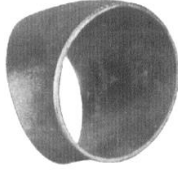

Nominal Size	Part Number	Approx. Wt/Lbs	Price
3"	ITWE 43	1.00	
4"	ITWE 44	1.00	
5"	ITWE 45	1.50	
6"	ITWE 46	2.00	
8"	ITWE 48	3.50	
10"	ITWE410	4.75	

11 1/4* Available at Same Price #ITWE14

22 1/2* Available at Same Price #ITWE24

Cast 90 Degree Welding Elbow



Nominal Size	Part Number	Approx. Wt/Lbs	Price
3"	ITWE 93	1.50	
4"	ITWE 94	1.74	
5"	ITWE 95	2.25	
6"	ITWE 96	4.00	
8"	ITWE 98	6.00	
10"	ITWE910	9.50	

Cast Welding Tee

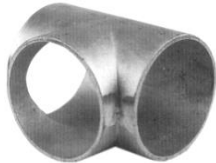

Size	Part Number	Wt/Lbs	Price
4"	ITWT 444	2.00	
5"	ITWT 555	2.50	
6"	ITWT 666	3.00	
8"	ITWT 888	5.75	
10"	ITWT101010	8.00	

Cast Aluminum Circles



Size	Part Number	Wt/Lbs	Price
4"	ITWD 400	1.50	
5"	ITWD 500	2.00	
6"	ITWD 600	2.25	
8"	ITWD 800	2.50	
10"	ITWD1000	3.00	
12"	ITWD1200	3.50	

Fabricated Aluminum Circles



Size	Part Number	Wt/Lbs	Price
4"	IACIRCLE04	0.25	
5"	IACIRCLE05	0.25	
6"	IACIRCLE06	0.50	
8"	IACIRCLE08	0.75	
10"	IACIRCLE10	1.00	
12"	IACIRCLE12	1.50	

KROY INDUSTRIES, INC.

Prices Effective: January 1, 2020. Prices Subject to Change Without Notice
 Phone: 402-362-6651 or 888-477-5769 * Fax: 402-362-6566 * York, Nebraska

Custom Fabrication & Specialty Items

Aluminum

Cast Aluminum Concentric Cone



Size	Part Number	Wt/Lbs	Price
4"x5"	ITWC 405	1.25	
4"x6"	ITWC 406	1.50	
5"x6"	ITWC 506	1.75	
6"x8"	ITWC 608	2.25	
8"x10"	ITWC8010	4.00	
10"x12"	ITWC1012	6.00	

Fabricated Aluminum Cone



Size	Part Number	Wt/Lbs	Price
4"x6"	IK14500406	0.75	
6"x8"	IK14500608	1.00	
6"x8" HD	IK14500608HD	1.05	
8"x10"	IK14500810	1.50	
10"x12"	IK14501012	1.75	

Cast Aluminum Eccentric Cone

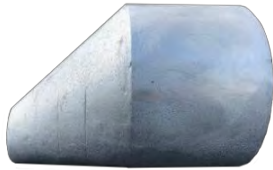

Size	Part Number	Wt/Lbs	Price
2½"x6"	ITESA2506	3.25	
3"x7"	ITESA3007	4.00	
3"x8"	ITESA3008	5.25	

Cast Aluminum Weld-On Adapter



For installation of weld on valves and fabricated fittings

Size	Part Number	Wt/Lbs	Price
3" x 3"	ITWAD303	0.38	
3" x 4"	ITWAD304	0.38	
3" x 5"	ITWAD305	0.38	
3" x 6"	ITWAD306	0.38	
4" x 4"	ITWAD404	0.50	
4" x 5"	ITWAD405	0.50	
4" x 6"	ITWAD406	0.50	
4" x 8"	ITWAD408	0.50	
5" x 5"	ITWAD505	0.75	
5" x 6"	ITWAD506	0.75	
5" x 7"	ITWAD507	0.75	
5" x 8"	ITWAD508	0.75	
5" x 10"	ITWAD510	0.75	
6" x 6"	ITWAD606	0.75	
6" x 8"	ITWAD608	1.00	
8" x 8"	ITWAD808	1.00	
10" x 10"	ITWAD1010	1.00	

Stamped Aluminum Saddle Adapter



Size	Part Number	Wt/Lbs	Price
4" x 6"	ITSVA642	0.45	
4" x 8"	ITSVA842	0.45	
4" x 10"	ITSVA1042	0.45	

KROY INDUSTRIES, INC.

Prices Effective: January 1, 2020.

Prices Subject to Change Without Notice

Phone: 402-362-6651 or 888-477-5769 * Fax: 402-362-6566 * York, Nebraska

Custom Fabrication & Specialty Items

Aluminum

Aluminum Companion Flange



Size	Part Number	Price
3"	ITAPF300	
4"	ITAPF400	
5"	ITAPF500	
6"	ITAPF600	
8"	ITAPF800	
10"	ITAPF1000	
12"	ITAPF1200	
14"	ITAPF1400	

Companion Flange Gasket Full Faced

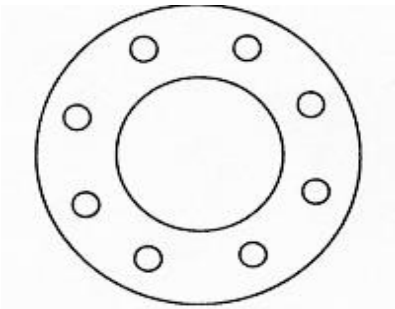

Size	Part Number	Price
3"	ITCPF- 3-GF	
4"	ITCPF- 4-GF	
5"	ITCPF- 5-GF	
6"	ITCPF- 6-GF	
8"	ITCPF- 8-GF	
10"	ITCPF-10-GF	
12"	ITCPF-12-GF	

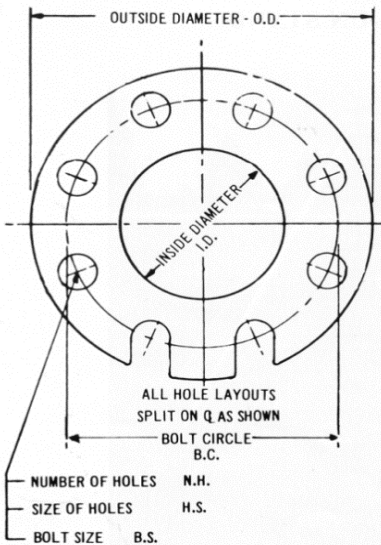

PIPE SIZE	O.D.	I.D.	B.C.	N.H.	H.S.	B.S.
2"	6"	2"	4 ³ / ₄ "	4	3/4"	5/8"
3"	7 ¹ / ₂ "	3"	6"	4	3/4"	5/8"
4"	9"	4"	7 ¹ / ₂ "	8	3/4"	5/8"
5"	10"	5"	8 ¹ / ₂ "	8	7/8"	3/4"
6"	11"	6"	9 ¹ / ₂ "	8	7/8"	3/4"
8"	13 ¹ / ₂ "	8"	11 ³ / ₄ "	8	7/8"	3/4"
10"	16"	10"	14 ¹ / ₄ "	12	1"	7/8"
12"	19"	12"	17"	12	1"	7/8"

KROY INDUSTRIES, INC.

Prices Effective: January 1, 2020. Prices Subject to Change Without Notice
 Phone: 402-362-6651 or 888-477-5769 * Fax: 402-362-6566 * York, Nebraska

Custom Fabrication & Specialty Items - Aluminum

Aluminum

Half and Full Nipples

Male Threaded

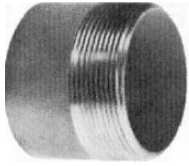

Half Nipple

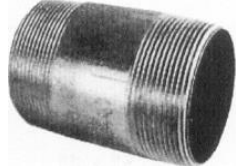

Full Nipple

Half Nipple

Full Nipple

Size	Half Nipple Part Number	Half Nipple Price	Full Nipple Part Number	Full Nipple Price
1/2"	IKNA050		IKFNA050	
3/4"	IKNA075		IKFNA075	
1"	IKNA100		IKFNA100	
1 1/4"	IKNA125		IKFNA125	
1 1/2"	IKNA150		IKFNA150	
2"	IKNA200		IKFNA200	
2 1/2"	IKNA250		IKFNA250	
3"	IKNA300		IKFNA300	
4"	IKNA400		IKFNA400	
5"	IKNA500		IKFNA500	
6"	IKNA600		IKFNA600	
8"	IKNA800		IKFNA800	
10"	IKNA1000		IKFNA1000	

Aluminum

Half and Full Couplings

Female Threaded



Half Coupling



Full Coupling

Half Coupling

Full Coupling

Size	Half Coup. Part Number	Half Coup. Price	Full Coup. Part Number	Full Coup. Price
1/2"	IKHC050		IKFC050	
3/4"	IKHC075		IKFC075	
1"	IKHC100		IKFC100	
1 1/4"	IKHC125		IKFC125	
1 1/2"	IKHC150		IKFC150	
2"	IKHC200		IKFC200	
2 1/2"	IKHC250		IKFC250	
3"	IKHC300		IKFC300	
4"	IKHC400		IKFC400	
5"	IKHC500		IKFC500	
6"	IKHC600		IKFC600	

Aluminum Saddle Coupling



Size	Part Number	Price
3/4" Outlet	ITSC 75	
1" Outlet	ITSC100	

Weld-On Latch Pocket



Fits	Part Number	Price
3" & 4"	ITWLP34	
5" & 6"	ITWLP56	

Welds to aluminum tubing to accept steel latch.

Weld-On Hook Brackets



(A)

(B)

(C)

Description	Part Number	Price
(A) WHB	IK 2076	
(B) WHB	IK 2078	
(C) BR 8	IK 2077	

Welds to aluminum tubing to accommodate steel latch.

KROY INDUSTRIES, INC.

Prices Effective: January 1, 2020. Prices Subject to Change Without Notice
 Phone: 402-362-6651 or 888-477-5769 * Fax: 402-362-6566 * York, Nebraska

Custom Fabrication & Specialty Items - Steel

Black Steel Companion Flange



Size	Part Number	Wt/Lbs	Price
3"	SK330003	5.00	
4"	SK330004	6.75	
5"	SK330005	7.25	
6"	SK330006	9.25	
8"	SK330008	12.50	
10"	SK330010	17.00	
12"	SK330012	24.25	

Full Faced Gasket

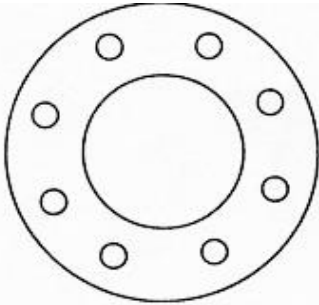

Size	Part Number	Price
3"	ITCPF- 3-GF	
4"	ITCPF- 4-GF	
5"	ITCPF- 5-GF	
6"	ITCPF- 6-GF	
8"	ITCPF- 8-GF	
10"	ITCPF-10-GF	
12"	ITCPF-12-GF	

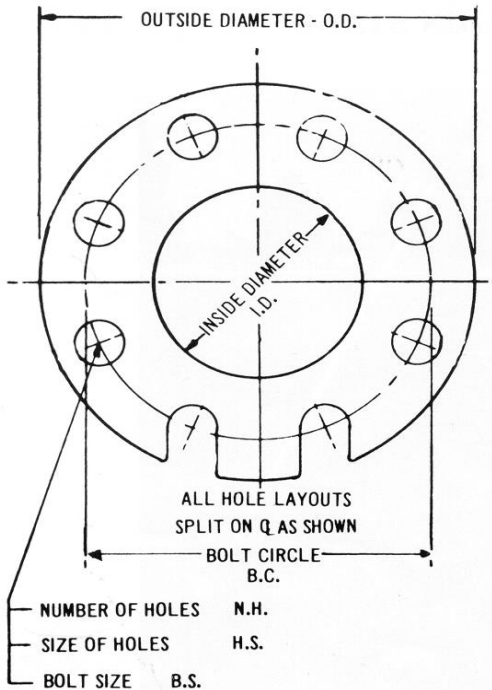

PIPE SIZE	O.D.	I.D.	B.C.	N.H.	H.S.	B.S.
2"	6"	2"	4 ³ / ₄ "	4	3/4"	5/8"
3"	7 ¹ / ₂ "	3"	6"	4	3/4"	5/8"
4"	9"	4"	7 ¹ / ₂ "	8	3/4"	5/8"
5"	10"	5"	8 ¹ / ₂ "	8	7/8"	3/4"
6"	11"	6"	9 ¹ / ₂ "	8	7/8"	3/4"
8"	13 ¹ / ₂ "	8"	11 ³ / ₄ "	8	7/8"	3/4"
10"	16"	10"	14 ¹ / ₄ "	12	1"	7/8"
12"	19"	12"	17"	12	1"	7/8"

KROY INDUSTRIES, INC.

Prices Effective: January 1, 2020. Prices Subject to Change Without Notice
 Phone: 402-362-6651 or 888-477-5769 * Fax: 402-362-6566 * York, Nebraska

Custom Fabrication & Specialty Items - Steel

Black Steel Nipples

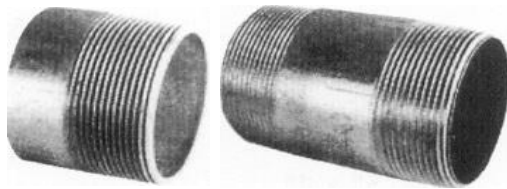

Half Nipple

Full Nipple

Size	Half Nipple Part Number	Half Nipple Price	Full Nipple Part Number	Full Nipple Price
3/4"	SKNA075		SKFNA075	
1"	SKNA100		SKFNA100	
1 1/4"	SKNA125		SKFNA125	
1 1/2"	SKNA150		SKFNA150	
2"	SKNA200		SKFNA200	
2 1/2"	SKNA250		SKFNA250	
3"	SKNA300		SKFNA300	
4"	SKNA400		SKFNA400	
5"	SKNA500		SKFNA500	
6"	SKNA600		SKFNA600	

Black Steel Couplings

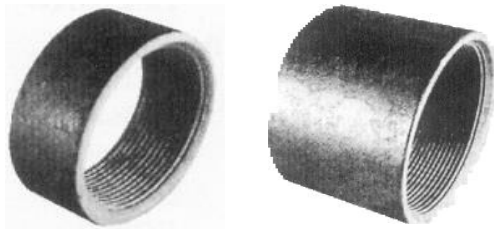

Half Coupling

Full Coupling

Size	Half Coup. Part Number	Half Coup. Price	Full Coup. Part Number	Full Coup. Price
3/4"	SKHC075		SKFC075	
1"	SKHC100		SKFC100	
1 1/4"	SKHC125		SKFC125	
1 1/2"	SKHC150		SKFC150	
2"	SKHC200		SKFC200	
2 1/2"	SKHC250		SKFC250	
3"	SKHC300		SKFC300	
4"	SKHC400		SKFC400	
5"	SKHC500		SKFC500	
6"	SKHC600		SKFC600	

Black Weld-On Rings



Size	Part Number	Price
6"	SH137506	
8"	SH137508	
10"	SH137510	

Bolt-On Lock Ring



Size	Part Number	Price
6"	SH138006	
8"	SH138008	
10"	SH138010	

Steel Weld-On Hook Brackets



Hook Boss



Hook Bracket

Description	Part Number	Price
Lg. Hook Boss	IK2072	
Sm. Hook Boss	IK2073	
Sm. Hook Bracket	IK2074	
Lg. Hook Bracket	IK2075	

KROY INDUSTRIES, INC.

Prices Effective: January 1, 2020.

Prices Subject to Change Without Notice

Phone: 402-362-6651 or 888-477-5769 * Fax: 402-362-6566 * York, Nebraska

Custom Fabrication & Specialty Items - Steel

Black Welding Cones



Heavy Duty 10 GA.

Size	Part Number	Price
4 x 6	STBWC46HD	
6 x 8	STBWC68HD	
8 x 10	STBWC810HD	
10 x 12	STBWC1012HD	

Size	Part Number	Wt./Lbs.	Price
2 x 3	STBWC 23	0.5	
2 x 4	STBWC 24	1.0	
3 x 4	STBWC 34	0.5	
3 x 5	STBWC 35	1.5	
4 x 5	STBWC 45	0.7	
3 x 6	STBWC 36	2.0	
4 x 6	STBWC 46	1.7	
5 x 6	STBWC 56	0.9	
6 x 7	STBWC 67	1.0	
4 x 8	STBWC 48	3.9	
5 x 8	STBWC 58	3.0	
6 x 8	STBWC 68	2.1	
7 x 8	STBWC 78	1.4	
8 x 10	STBWC 810	3.3	
9 x 10	STBWC 910	2.2	
10 x 12	STBWC1012	4.5	

12 Gauge is standard.

Black Eccentric Adapter Cones



Size	Part Number	Wt./Lbs.	Price
3 x 2	STBEC 32	2.6	
4 x 2	STBEC 42	3.0	
4 x 3	STBEC 43	2.5	
5 x 3	STBEC 53	3.8	
5 x 4	STBEC 54	3.3	
6 x 3	STBEC 63	5.0	
6 x 4	STBEC 64	4.3	
6 x 5	STBEC 65	3.8	
8 x 4	STBEC 84	10.5	
8 x 5	STBEC 85	10.0	
8 x 6	STBEC 86	8.8	
10 x 6	STBEC 106	14.0	
10 x 8	STBEC 108	12.5	
12 x 6	STBEC 126		
12 x 8	STBEC 128		
12 x 10	STBEC1210		

Steel Welding Disc



Size	Part Number	Price
2"	STWD -2	
3"	STWD -3	
4"	STWD -4	
5"	STWD -5	
6"	STWD -6	
7"	STWD -7	
8"	STWD -8	
10"	STWD-10	
12"	STWD-12	

KROY INDUSTRIES, INC.

Prices Effective: January 1, 2020.

Prices Subject to Change Without Notice

Custom Fabrication & Specialty Items - Steel

Black Weld-On 90° Elbow

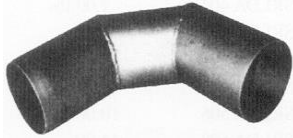

12 Ga. Standard/HD Elbows Available Upon Request

Size	Part Number	Wt./Lbs.	Price
3	SK134603	4.0	
4	SK134604	6.0	
5	SK134605	8.0	
6	SK134606	10.0	
7	SK134607	11.0	
8	SK134608	12.0	
10	SK134610	15.0	

Black Weld-On 45° Elbow

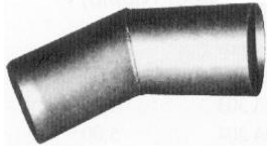

12 Ga. Standard/HD Elbows Available Upon Request

Size	Part Number	Wt./Lbs.	Price
3	SK135603	3.0	
4	SK135604	5.0	
5	SK135605	7.0	
6	SK135606	9.0	
7	SK135607	10.0	
8	SK135608	11.0	
10	SK1356010	13.0	

Black Weld-On Heavy Duty 45° Sweep Elbow



Size	Part Number	Wt./Lbs.	Price
6	SK133306H		
8	SK133308H		

Black Weld-On Heavy Duty 90° Sweep Elbow



Size	Part Number	Wt./Lbs.	Price
6	SK133106H		
8	SK133108H		

KROY INDUSTRIES, INC.

Prices Effective: January 1, 2020. Prices Subject to Change Without Notice
Phone: 402-362-6651 or 888-477-5769 * Fax: 402-362-6566 * York, Nebraska

Custom Fabrication & Specialty Items

Hose Clamp



Diameter		Part Number	Price
From	To		
1 1/2"	3 1/2"	IHLS188	
3 1/2"	4 1/2"	IHLS188	
4 1/8"	5"	IHLS188	
5 1/8"	6"	IHLS188	
5 5/8"	6 1/2"	IHLS188	
5 5/8"	8 1/2"	IHLS188	
9 3/8"	12 1/4"	IHLS188	

T-Bolt Clamp



Diameter		Part Number	Price
MM	Inches		
98 - 103	3 7/8 - 4 1/8	IA4650.20	
104 - 112	4 1/8 - 4 7/16	IA4650.21	
113 - 121	4 7/16 - 4 13/16	IA4650.22	
131 - 139	5 3/16 - 5 1/2	IA4650.24	
149 - 161	5 7/8 - 6 3/8	IA4650.26	
162 - 174	6 3/8 - 6 7/8	IA4650.27	
201 - 213	7 15/16 - 8 7/16	IA4650.30	
214 - 226	8 7/16 - 8 15/16	IA4650.31	

Hold Bands



Size	Part Number	Price
4"	ITHB400	
5"	ITHB500	
6"	ITHB600	
8"	ITHB800	
10"	ITHB1000	

Draw Band

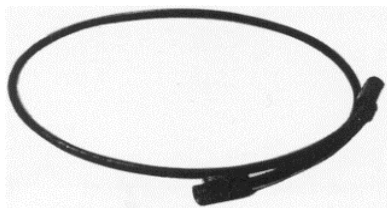

Size	Part Number	Price
4"	SCDBR04	
6"	SCDBR06	
8"	SCDBR08	
10"	SCDBR10	
12"	SCDBR12	
14"	SCDBR14	
15"	SCDBR15	
16"	SCDBR16	

Horseshoe Clamp



Size	Part Number	Price
6"	SH139006	
8"	SH139008	
10"	SH139010	

KROY INDUSTRIES, INC.

Prices Effective: January 1, 2020.

Prices Subject to Change Without Notice

Custom Fabrication & Specialty Items

AIR Relief Valve



Size	Part Number	Price
1 1/2"	ITAV150	
2"	ITAV200	
3"	ITAV300	
4"	ITAV400	

Quantity Discounts Available

Pressure Relief Valve



Size	PSI	Part Number	Price
2"	11-65	IW06001001	
2"	66-120	IW06001002	
3"	11-40	IW06003041	
3"	41-100	IW06003101	
3"	101-150	IW06003121	
4"	11-34	IW06004021	
4"	35-60	IW06004041	
4"	61-105	IW06004101	
4"	106-150	IW06004121	

Other Sizes Available Upon Request

Pipe Plug



Size	Part Number	Less Than 100	Over 100
1/2"	STZPP050		
3/4"	STZPP075		
1"	STZPP100		
1 1/4"	STZPP125		

Bushing



Size	Part Number	Less Than 100	Over 100
3/4" x 1/2"	STZB075X050		
1" x 1/2"	STZB100X050		
1" x 3/4"	STZB100X075		
1 1/4" x 3/4"	STZB125X075		
1 1/4" x 1"	STZB125X100		

KROY INDUSTRIES, INC.

Prices Effective: January 1, 2020. Prices Subject to Change Without Notice
 Phone: 402-362-6651 or 888-477-5769 * Fax: 402-362-6566 * York, Nebraska

Custom Fabrication & Specialty Items

Gaskets

Call Factory For Quantity Discounts

Kroy Gaskets

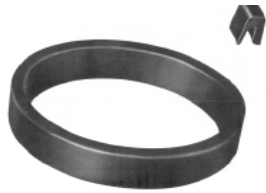

Size	Part Number	Price
5"	VTGSKTKROY05	
6"	VTGSKTKROY06	
8"	VTGSKTKROY08	
10"	VTGSKTKROY10	
12"	VTGSKTKROY12	

Midwest Gaskets



Size	Part Number	Price
6"	IH100006	
8"	IH100008	
10"	IH100010	
12"	IH100012	

Rainway Gaskets

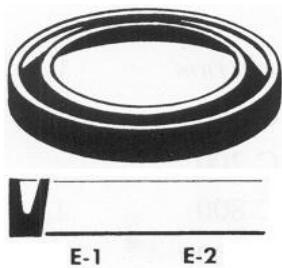

Size	Part Number	Price
2"	ITE -2 2	
3"	ITE -1 3	
4"	ITE -1 4	
5"	ITE -1 5	
6"	ITE -1 6	
7"	ITE -1 7	
8"	ITE -1 8	
10"	ITE-1 10	
12"	ITE-1 12	

Round Back Gaskets



Size	Part Number	Price
2"	STE - 32	
3"	STE - 33	
4"	STE - 34	
5"	STE - 35	
6"	STE - 36	
7"	STE - 37	
8"	STE - 38	
10"	STE-310	
12"	STE-312	
6 5/8" IPS	STE-6 5/8	
8 5/8" IPS	STE-8 5/8	

KROY INDUSTRIES, INC.

Prices Effective: January 1, 2020. Prices Subject to Change Without Notice
 Phone: 402-362-6651 or 888-477-5769 * Fax: 402-362-6566 * York, Nebraska

Custom Fabrication & Specialty Items

Gaskets

Call Factory For Quantity Discounts

Wade Gaskets



Size	Part Number	Price
2"	IW - 10-6-2M	
3"	IW - 10-6-3M	
4"	IW - 10-6-4M	
5"	IW - 10-6-5M	
6"	IW - 10-6-6M	
8"	IW - 10-6-8M	
10"	IW-10-6-10M	

Compression Gasket



Size	Part Number	Price
6" PIP	STPIPCG6	
8" PIP	STPIPCG8	
10" PIP	STPIPCG10	
6" IPS	STIPSCG6	
8" IPS	STIPSCG8	
10" IPS	STIPSCG10	

Watertight Gasket



Size	Part Number	Price
6" PIP	STPIP-BTG6	
8" PIP	STPIP-BTG8	
10" PIP	STPIP-BTG10	
6" IPS	STIPS-BTG6	
8" IPS	STIPS-BTG8	
10" IPS	STIPS-BTG10	

B Style "O" Ring Gasket



Size	Part Number	Price
4"	IA280OR4	
6"	IA280OR6	
8"	IA280OR8	
10"	IA280OR10	

A Style "O" Ring Gasket



Size	Part Number	Price
6"	SA2860R6L	
8"	SA2860R8	

KROY INDUSTRIES, INC.

Prices Effective: January 1, 2020. Prices Subject to Change Without Notice
 Phone: 402-362-6651 or 888-477-5769 * Fax: 402-362-6566 * York, Nebraska